

# Miniature/Pony In Hand Trail

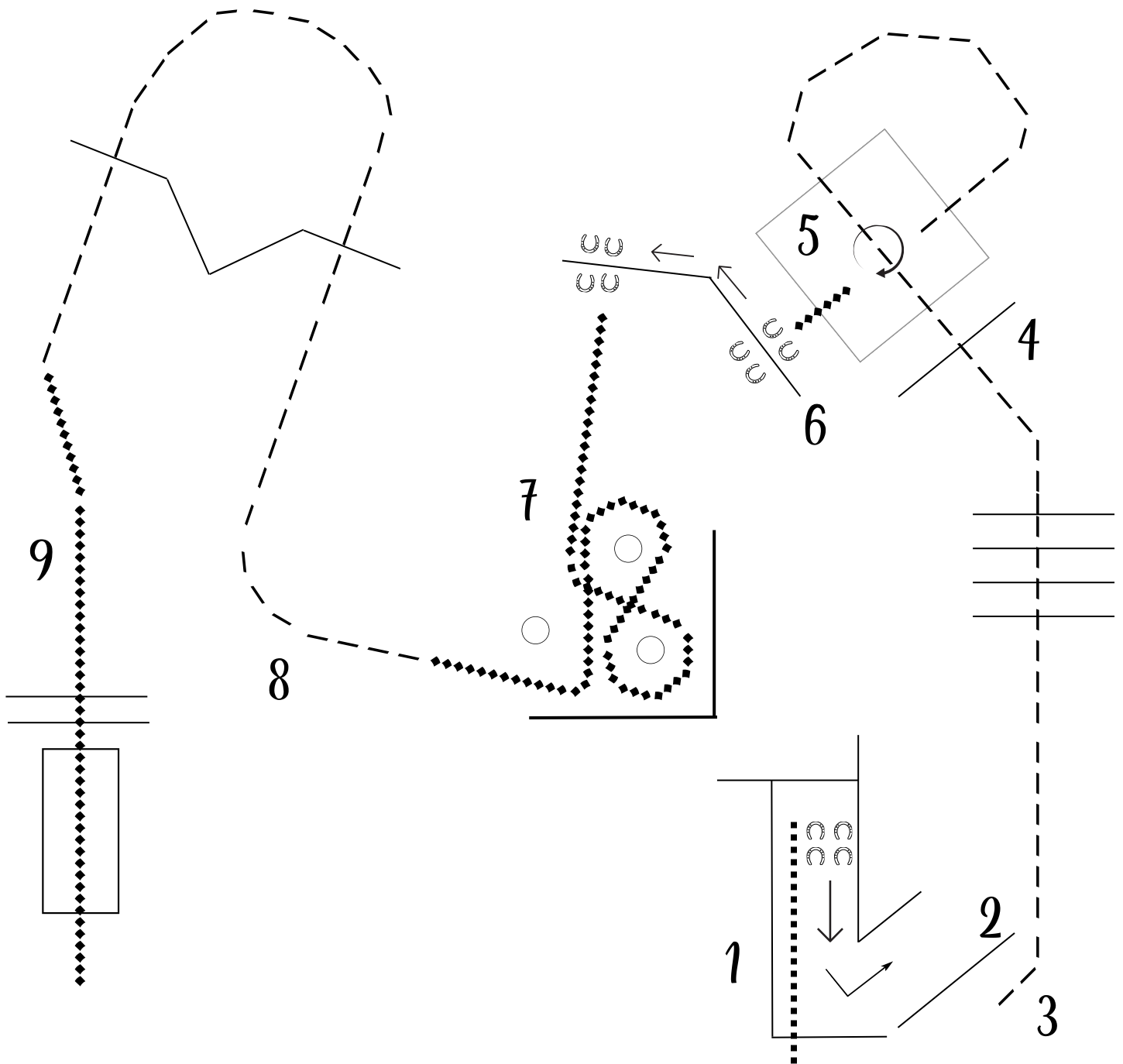

1. Walk into chute , back around corner
2. Left hand gate
3. Jog poles
4. Jog through box
5. Jog into box, stop. 360 to the right
6. Walk out, side pass right over poles
7. Walk cones
8. Jog poles
9. Walk poles and bridge

# Miniature/Pony In Hand Trail Challenge

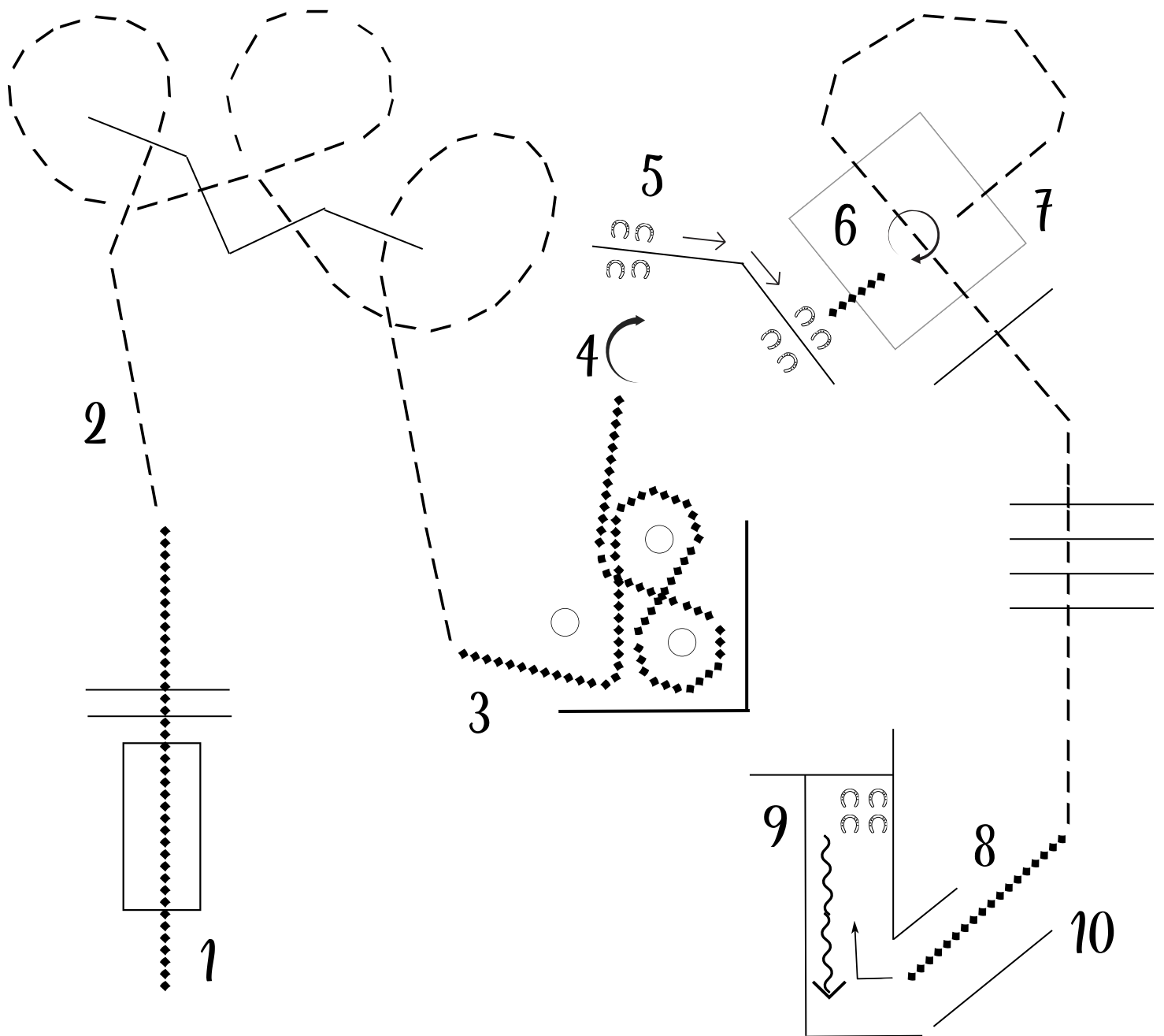

1. Walk bridge and poles
2. Jog poles
3. Back figure 8
4. 180 turn to the right
5. Side pass right over poles, walk into box
6. Stop in box, 360 to the right
7. Jog out of box, jog poles
8. Walk into chute
9. Back to gate
10. Left hand gate

# Miniature/Pony Showmanship

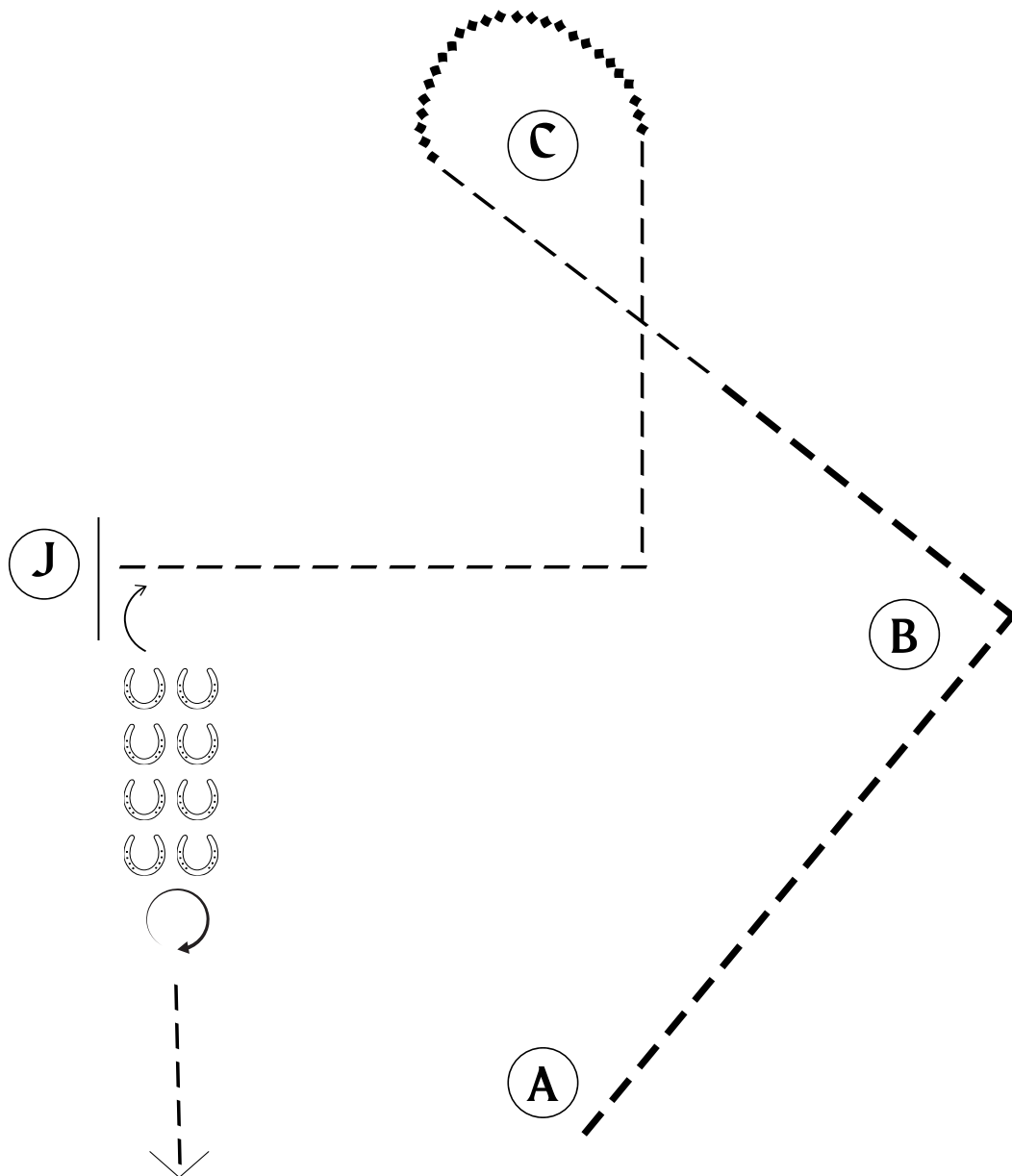

1. Be ready and set up at A
2. Extend jog from A to halfway between B and C
3. Jog and continue to C
4. At C, break to a walk and walk around C
5. Trot square corner from C to judge and stop
6. Set up for inspection
7. After inspection, pivot 90 degrees, back one horse length, and pivot 540 degrees
8. Trot out

# Miniature/Pony Hunter in Hand

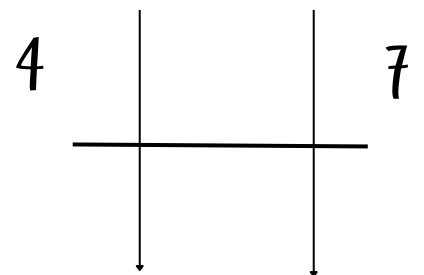
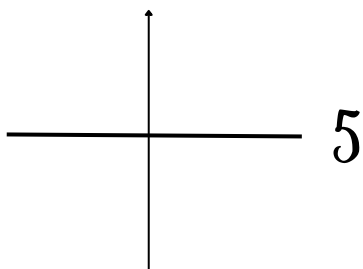
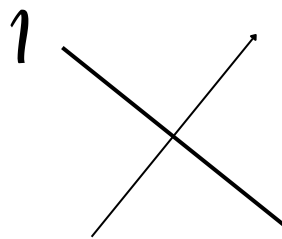
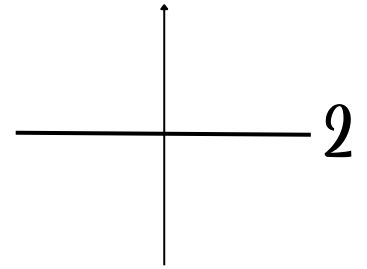
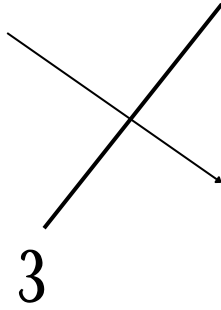
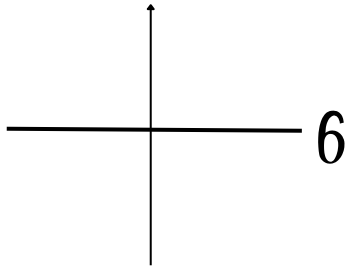

*Following your round, trot by judges for soundness*

# Miniature/Pony Jumping

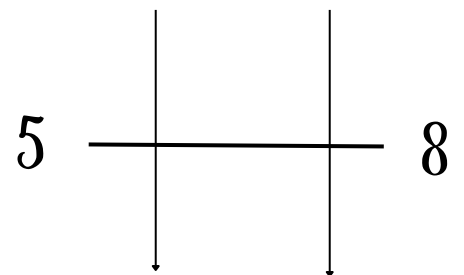
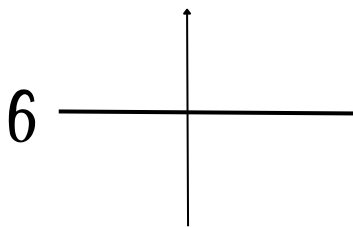
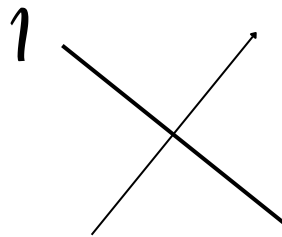
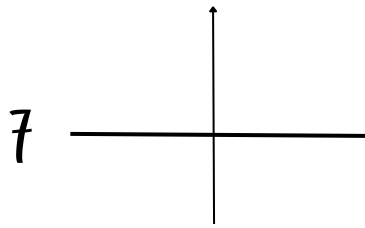
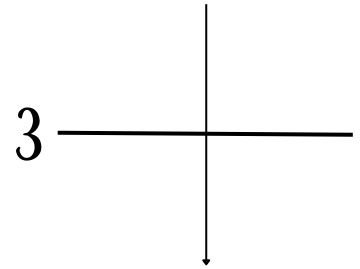
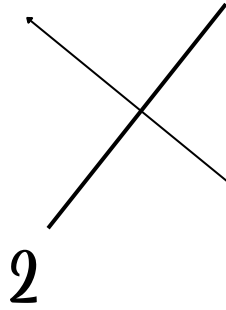
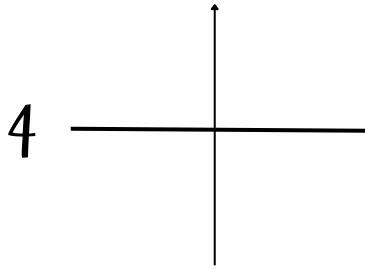

# Miniature/Pony Obstacle Driving

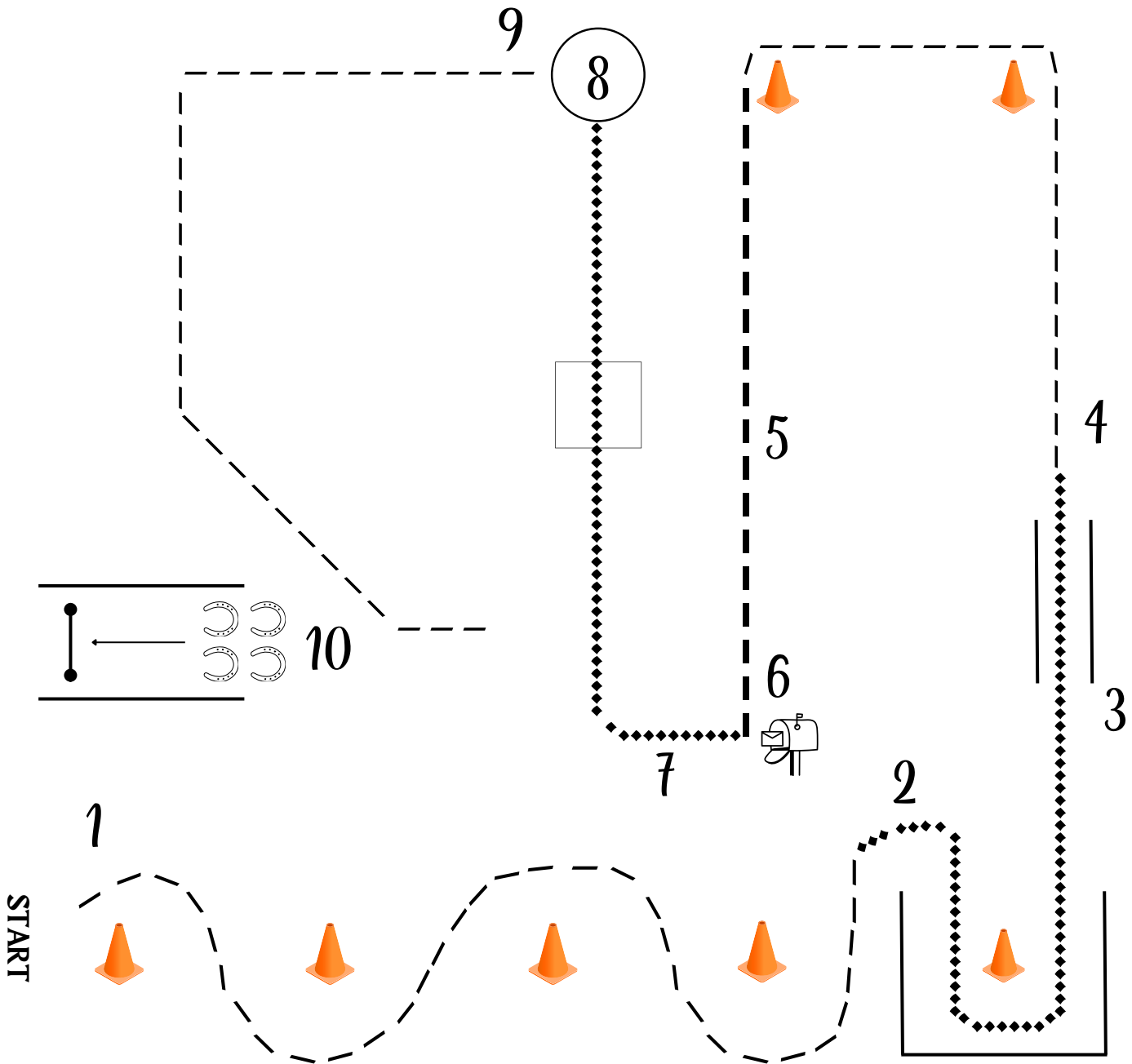

1. Trot through cones
2. Walk through "U"
3. Walk through the poles, keeping left wheel between poles
4. Trot around cones
5. Extend trot to mailbox. Stop.
6. Open and close mailbox.
7. Walk over tarp
8. Walk to hoop. Put one tire in hoop and perform a 90 turn to the left
9. Trot. Stop.
10. Back into bar, dropping it to the ground, walk out.

